

Table of Contents

1. GENERAL INFORMATION	2
A. Floating Floors	2
B. Megaloc™ Installation System	2
C. Intended Use	2
D. Precautions	2
2. TOOLS & MATERIALS	
3. BEFORE YOU BEGIN	3
A. Calculating Floor Material Requirements	3
B. Acclimation	3
C. Expansion Space	3
D. Maximum Room Size	3
E. Doorways	3
F. Installation Layout	3
G. Cutting Planks	3
4. SUBFLOOR PREPARATION	4
A. General Subfloor Preparations & Precautions	4
B. Concrete	4
C. Wood	5
D. Vinyl, Linoleum, or Ceramic Tile	5
5. ROOM PREPARATION	
A. Wall Base/Trim	5
B. Door Jam	5
C. Wall Irregularities	5
6. INSTALLATION PROCEDURES	6
A. First Row	6
B. All Other Rows	6
7. PLANK REMOVAL	
A. General	7
B. Replacing an Installed Plank without Replacing Adjacent Planks	7
8. WET AREA RECOMMENDATIONS	8
9. MOLDINGS	8
A. Mono-Track	8
B. Quarter Round	8
C. Square Nose	8
D. Reducer	9
E. T-Molding	9
F. Stair Nose	10
10. CARE & MAINTENANCE	10
A. Removing Stains from Laminate Floors	10

Congratulations and thank you for choosing inhaus® laminate floors! Your new floors are among the most fashionable, long-lasting and easy-to-maintain floors available, not to mention simple, quick and clean to install. This installation guide outlines everything you need to know to properly install and maintain inhaus® laminate floors. If you have questions at any time during the installation process, please contact your specialty floor covering retailer or us directly at 888.255.3412.

1. GENERAL INFORMATION

A. Floating Floor

inhaus® laminate floors are floating floors, which means they should not be glued, nailed or attached in any way to your existing subfloor. In addition, inhaus® laminate floors are made from wood and will expand and contract with changes in relative humidity levels (they will expand during moist conditions and contract during dry conditions). Care should be taken to leave appropriate spacing between walls and flooring (refer to Before You Begin, Section 1C, for expansion spacing). Cabinets of kitchen islands should be installed prior to the laminate flooring.

B. Megaloc™ Installation System

All inhaus® laminate floors are equipped with Megaloc™, the most advanced glueless installation system available. Each plank is milled with a patented tongue and groove design that allows for them to be connected without the use of glue. You will find that Megaloc™ is simple to use, quick to install and you won't require any flooring specific tools to install your floor.

C. Intended Use

inhaus® laminate floors are intended for indoor use only and can be installed in any room as long as it does not have in-floor drainage. All inhaus® floors have been designed to withstand the requirements of the busiest households (classified as general residential use) as well as light commercial applications. In addition, the following collections can be used in medium commercial applications:

- Traditional Vintage

- Urban Loft
- Natural Prestige
- Supreme Senses
- Timeless Impressions

If you are installing floors in a commercial environment, please read the warranty documentation specific to your product to determine its suitability.

D. Precautions

- Never tap inhaus laminate flooring during installation.
- Never use tools designed for other laminate flooring installation systems.
- Never wax, polish, or use abrasive cleaners on your inhaus laminate floor.



2. TOOLS AND MATERIALS

Materials

- inhaus® laminate floors
- inhaus® approved underlayment
- inhaus® approved vapor barrier (if needed)
- inhaus® transitional moldings (if needed)

Tools

- Measuring tape
- Carpenter's square
- 2" (51mm) wide moisture resistant adhesive tape
- Utility knife
- Safety glasses
- Dust mask (NIOSH-designated)
- Pencil/marker
- Pull bar
- 3/8" (10mm) thick spacers
- Power saw (any of the following):

- o Table saw
- o Miter saw
- o Circular saw
- o Jigsaw
- Handsaw or doorjamb saw

3. BEFORE YOU BEGIN

A. Calculating Flooring Material Requirements

- Measure the length and width of the room where you will be installing inhaus® laminate floors and multiply them together to determine its area.
- Add 10% to the room's area to determine the square footage of inhaus® laminate flooring, underlay, and vapor barrier that you will require.

B. Acclimation

inhaus® laminate floors must be acclimated to the conditions of your home before they are installed. To do so, cross-stack unopened cartons in the area where they will be installed and away from outside walls, heat and air conditioning vents. Allow 48 hours for your floors to acclimate to the conditions of the installation area before opening the cartons. Installation temperatures should be at a minimum of 64° F (18° C) with a maximum relative humidity of 75%.

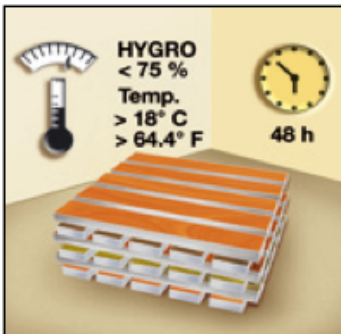

C. Expansion Space

inhaus® laminate floors expand and contract with changes in relative humidity. For this reason, it is necessary to leave a 3/8" (10mm) expansion space around the perimeter of the room and all other objects (e.g. toe kicks, plumbing, etc.). The expansion space will be covered by the wall base or quarter round once the floor is installed.

D. Maximum Room Size

inhaus® laminate floors can be installed in a single room up to 40 linear feet (12m) in length or 40 linear feet (12m) in width. Installations in rooms that are over 40 linear feet in length or width must use T-moldings (Refer to Moldings, Section 9E, for more information on T-moldings.)

E. Doorways

If installing inhaus® laminate floors through doorways (e.g. between hallway and bedroom) it is recommended that T-moldings be used to separate the rooms.

F. Installation Layout

There are no rules when it comes to the layout of your installation. Typically, laminate flooring installations are laid out in the following manner:

- Parallel to the longest wall in the room, or
- Parallel to the main window in the room

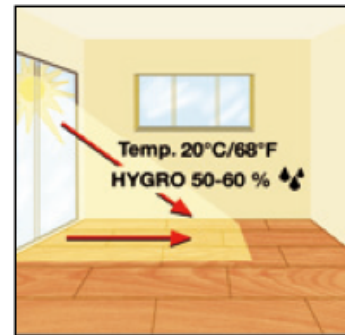

G. Cutting Planks

inhaus® laminate flooring planks can be cut with most power saws (e.g. circular saw, table saw, miter saw, jigsaw) as well as hand saws. It is important to use good quality, sharp saw blades in order to minimize chipping to the planks; however, small chips will be hidden by the wall base or trim.

Note: Planks should always be cut away from the installation area in order to keep dust from affecting the site. Always wear safety glasses and a NIOSH-approved dust mask.

4. SUBFLOOR PREPARATION

inhaus® laminate floors can be installed over many types of subfloors as long as they are properly prepared and meet the required criteria outlined below.

A. General Subfloor Preparations & Precautions

- Subfloors must be clean and free of dirt and debris prior to installation.
- Subfloors must be structurally sound prior to installation.
- Subfloor moisture must be tested prior to installation and should not exceed 12% throughout the installation area.
- Carpet is not a suitable underlay for laminate floors. All carpet, carpet pad and carpet tack should be removed prior to installation.
- inhaus® laminate floors can be installed in bathrooms, kitchens, and entryways by following the Wet Area Recommendations section of this guide.
- Variations in the subfloor flatness should not exceed 1/16" per 3ft (2mm/m). Floors must be leveled to meet this specification prior to installation. Level by filling depressed areas with floor leveling compounds and sanding or grinding down raised any areas.

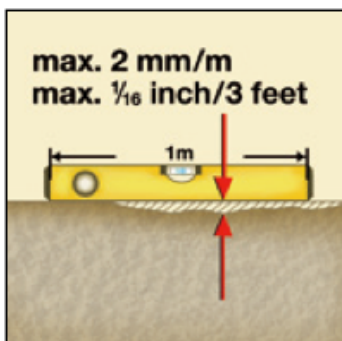

- Installations over radiant heated subfloors are acceptable but temperature should never exceed **80° F (27° C)**.
 - Radiant heat systems must be operating for a minimum of 3 weeks prior to installation of inhaus® laminate floors.

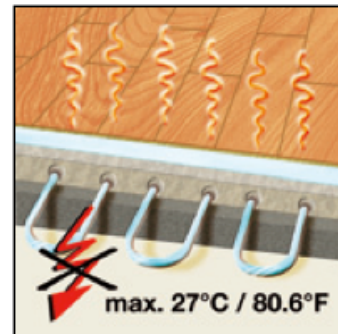

B. Concrete

Concrete subfloors must be properly cured and allowed to dry for at least 60 days prior to installation. Test concrete subfloor for moisture prior to installation. To do so:

- Tape 3' x 3' (91cm x 91cm) pieces of polyethylene vapor barrier to subfloor.
- If condensation appears on the film after 24 hours or concrete appears dark in color moisture is likely present and a Calcium Chloride test must be performed.
- The maximum allowable moisture emission is 5.0 lbs/1000 ft² per 24 hours (2.26kg/101.6 m² per 24 hours).
- A 0.12" (3mm) thick underlay and 8 mil (0.2mm) polyethylene vapor barrier must be used when installing over concrete.

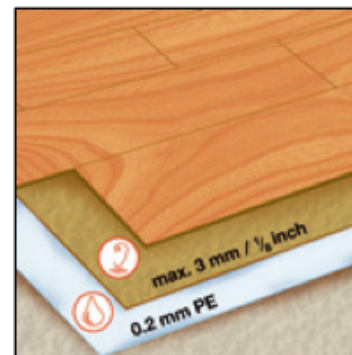

- Overlap vapor barrier edges by 8" (20cm) and seal with moisture resistant adhesive tape.
- Run vapor barrier 3/4" (2cm) up wall and trim after wall base is installed.

- Underlay edges should not be overlapped. Butt end edges together and seal with adhesive tape.

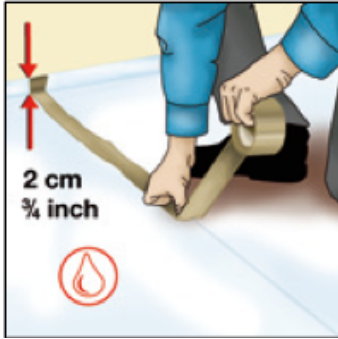

C. Wood

- Wood subfloors must be structurally sound and screwed or nailed to supporting beams.
- Do not install inhaus® laminate floors over wood subfloors applied directly to concrete.
- If installing floors over a crawl space it is recommended that an 8 mil (0.2mm) vapor barrier be installed.
 - Overlap vapor barrier edges by 8" (20cm) and seal with moisture resistant adhesive tape.
 - Run vapor barrier 3/4" (2cm) up wall and trim after wall base is installed.
- A 3mm thick underlay must be installed prior to installation of inhaus® laminate floors.

D. Vinyl (sheet/tile), Linoleum, Ceramic Tile

- If vinyl, linoleum, or ceramic tile is installed over concrete an 8 mil (0.2mm) vapor barrier must be installed over it.
 - Overlap vapor barrier edges by 8" (20cm) and seal with moisture resistant adhesive tape.
 - Run vapor barrier 3/4" (2cm) up wall and trim after wall base is installed.
- A 0.12" (3mm) thick underlay must be installed prior to installation of inhaus® laminate floors.

5. ROOM PREPARATION

A. Wall Base/Trim

- Removal of existing wall base/trim is optional.

- Wall base or trim will need to be installed once the flooring installation is complete to cover the expansion space around the perimeter of the room.
- Always nail/adhere wall base and trim to the wall. Never nail/adhere it to the laminate flooring.

B. Doors/Door Jambs

inhaus® laminate floors should be installed under door jambs so your door jambs will need to be undercut accordingly. To do so:

- Use a laminate flooring off-cut and a small piece of underlay to support your saw blade at the correct height for undercutting.

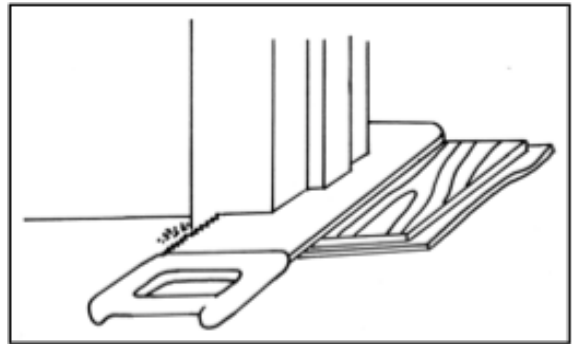

- Check door clearances and make any necessary height adjustments before installing inhaus® laminate floors.
- Make sure to leave the correct expansion spacing.

C. Wall Irregularities

Walls are not always perfectly straight. inhaus® laminate floors will need to be cut so as to fit within irregularities of your walls. To do so:

1. Install a complete, first row of inhaus® laminate floors (following the Installation Procedures below) and ensure that all long edges of the laminate flooring are aligned flush with one other.
2. Slide the whole row against the wall; you will now notice any of these irregularities (i.e. areas where the wall is not straight.)
3. Trace the contour of the wall onto the row of laminate flooring with a pencil or marker.

4. Once traced, uninstall the planks carefully so as to not damage the locking system and cut along the traced line (see [Plank Removal Guidelines](#), Section 7A.)
5. Re-install the plank leaving the necessary 3/8" (10mm) expansion space.

6. INSTALLATION PROCEDURES

- It is recommended that planks be mixed from at least three cartons to achieve the most natural and varied results.
- Inspect every plank for damage before installing it.
- The first and last row of the installation should be wider than 3.5" (9cm). To ensure this will be the case, prior to installation:
 1. Measure the width of the room and divide it by the width of the planks you are installing.
 2. If the remainder is less than 3.5" (9cm) cut 3.5" (9cm) from the width of the first row. If this is not possible, simply ensure that both edge planks are as even in width as possible.
- The first and last plank in a row should be a minimum of 16" (40cm) long.
- Stagger the planks from row to row by a minimum of 16" (40cm).
- Prepare the subfloor and room as per the corresponding instructions found in this guideline.
- Use spacers to maintain the 3/8" (10cm) expansion space between the first row and the wall.
- Select a starting corner of the room and work from left to right.

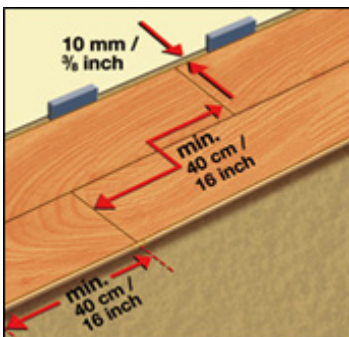

TIP: If possible, it is often easiest to start at the door of the room so that the first plank can be easily slid under the door jamb.

A. FIRST ROW

1. Lay the first plank with the long edge tongue facing the wall.
2. Lift the right side of the second plank to a 30-degree angle and place its short end tongue into the groove of the first plank.

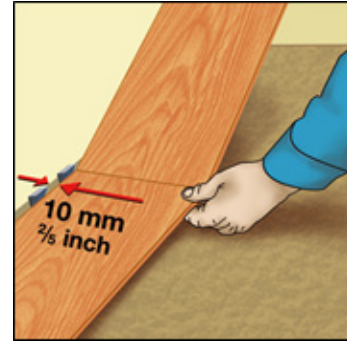

3. Lower the plank to lock the two together.
4. Continue in this manner until the first row is complete.
5. Use the remainder of the last plank of the first row to start the second row provided that it is a minimum of 16" (40cm) long.

B. ALL OTHER ROWS

1. Install the first plank of the second row by installing its long edge to the previous row's groove in a similar manner as you installed the short edges of the first row (i.e. 30 degree angle and lower).
2. Install remaining planks as follows:
 - Install the long edge of the plank to the previous row
 - Before lowering the plank, make sure it's short end tongue overlaps with the previous plank's short end groove.
 - Lower the plank slowly (a short oscillating or up-and-down motion may help lower the plank)
 - Apply pressure to the planks short edge so as to activate the Megaloc™ locking mechanism. You will typically hear an audible click sound.

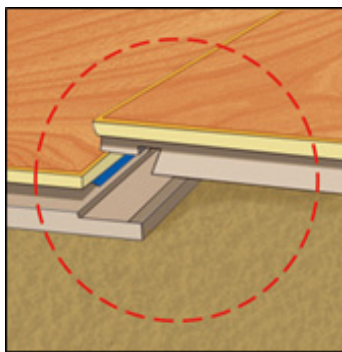
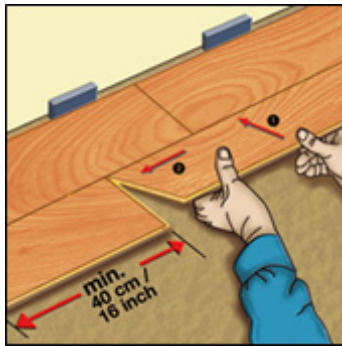
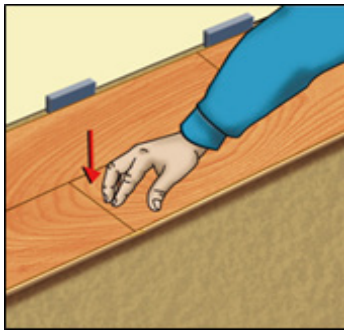

7. PLANK REMOVAL

A. General Removal

To remove planks, simply reverse the installation process. If you plan to re-install them, care should be taken so as not to damage the installation mechanism.

- Uninstall the last installed row all at once by lifting the long edge of the row to approximately 30° in order to disconnect the long edge installation mechanism.
- Then, disconnect each individual plank from one another by starting at the right-most plank and lifting its right end approximately 30° to disconnect the short edge installation mechanism.

B. Replacement of an Installed Plank Without Uninstalling Adjacent Planks (i.e. Middle of a Room)

The following steps should be taken if a plank in the middle of a room needs to be replaced and it is impractical to uninstall all adjacent rows.

Note: After completing the steps outlined below, the new plank will be permanently installed as it will be glued to adjacent planks.

- Select a replacement plank, making sure that it is the right size and style. Ideally, the replacement plank is one that was left over from the original installation.
- With a pencil or marker, accurately draft out the following:
 - Inside rectangle 1.5" (38mm) from the plank's edges
 - Mark location for drill holes as follows:
 1. Corners of inside rectangle and corners of the plank
 2. Make relief cuts at one-third the length of the plank
- Drill 3/16" holes in each of the A and B locations. In location B, drill the hole along the edge of the plank while being careful not to damage the adjacent planks. It is recommended that drill holes are marked with a punch prior to drilling. (See Figure 1 and 2.)
- Take a circular saw and set its depth to the plank's thickness.
- Cut along the inside square and remove centre sections. Be sure to protect all adjacent planks so as not to damage them while cutting.

Figure 1

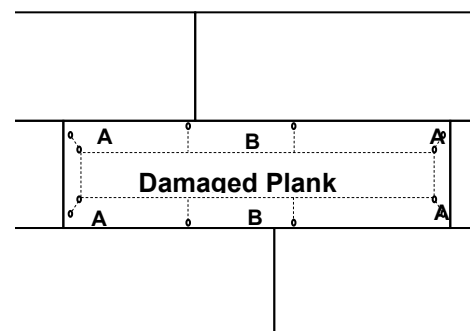
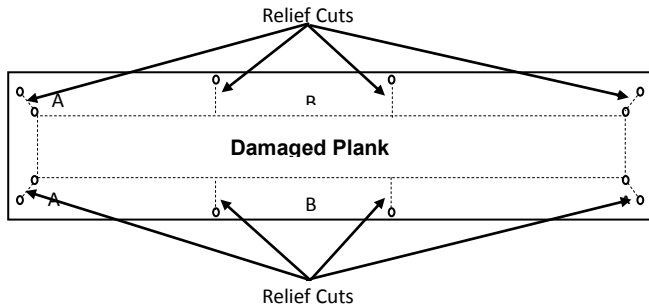
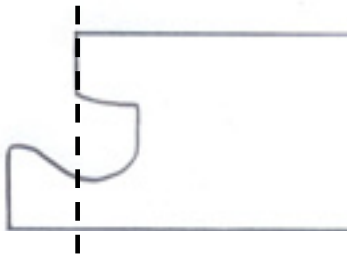

Figure 2



- Make relief cuts to outside of A and B drill holes using the holes for stops so as to avoid damaging adjacent planks.
- Carefully remove the centre relief cut sections first.
- Cut towards the corners next and remove the end pieces last.
- Clean and vacuum any debris that has accumulated during the cutting process.
- Prepare the new plank for insertion by removing the grooves on the long and short sides of the plank using table saw, sharp utility knife, chisel or small block plane.



The replacement plank will now have all grooves removed but tongues intact.



- Apply laminate flooring glue or white wood glue around the four sides of the new plank.
- Install the replacement plank into the opening created by placing the long end tongue into the adjacent plank's groove and lowering it into position.
- Remove any excess glue with a damp clean cloth.
- Ensure that all of the joints fit tightly.

- Evenly distribute heavy weights on the new plank for 24 hours.

Note: Damage to planks or performance issues stemming from this procedure will not be covered under warranty. It is recommended that this procedure be performed by a capable professional installer.

8. WET AREA RECOMMENDATIONS

Special procedures should be followed when installing inhaus® laminate floors in areas that are prone to moisture (e.g. bathrooms, kitchens, or entryways).

- Always install an 8mil (0.2mm) vapor barrier prior to installing the underlay and laminate flooring.
 - Overlap vapor barrier edges by 8" (20cm) and seal with moisture resistant adhesive tape.
 - Run vapor barrier ¾" (2cm) up wall and trim after wall base is installed.
- Fill all expansion spaces with 100% silicone caulking (caulking is flexible and will still allow inhaus® laminate floors to expand and contract).
- The toilet must be removed when installing inhaus® laminate floors in bathrooms and a 3/8" (10cm) expansion must be left between the flooring edge and the toilet flange. The expansion space must be filled with 100% silicon caulking.

inhaus® laminate flooring is made from wood and excessive exposure to moisture will damage the planks. It is strongly recommended that spills be wiped up immediately.

9. MOLDINGS

- Moldings can be attached with metal track (except for quarter round and stair nose) 6d finishing nails or construction adhesive (eg. Liquid Nails, PL 400). When using adhesive weigh down moldings evenly to ensure proper adhesion. Be careful not to use too much adhesive as it could fill the expansion zone.
- Never fasten moldings directly to the laminate flooring.
- Ensure that you leave at least 3/8" (10mm) expansion space between moldings and laminate floors.
- If installing over radiant heated floors, always use construction adhesive to attach the moldings.
- Always pre-drill moldings with appropriate size drill bit to avoid cracking or splitting.

A. Metal Track

The metal track system can be used to install T-moldings, reducers and square nose moldings. Simply screw or nail the track to the sub-floor and snap the molding in place.

B. Quarter Round

Quarter rounds are used to cover the space between the floor and existing baseboards. Nail quarter rounds to the wall, not the floor. Do not force the trim against the floor.

C. Square Nose

Square nose moldings provide a transition between laminate floors and a vertical surface such as toe-kicks and sliding glass doors. These moldings can also be used to transition between carpets and tile.

If installing with metal track:

1. Install track first
2. Install laminate floor up to track leaving a 3/8" (10mm) expansion space between the laminate floor and the vertical section of the molding.

If installing without metal track:

1. Measure so as to ensure that a 3/8" (10mm) space will be left between the laminate floor and the vertical part of the molding.
2. Install the laminate floors up to the measured point.

3. Install the molding.

D. Reducer

Reducers are used to transition from laminate floors to surfaces of a lesser height such as vinyl floors.

If installing with metal track:

1. Install track first
2. Install laminate floor up to track leaving a 3/8" (10mm) expansion space between the laminate floor and the vertical section of the molding.

If installing without metal track:

1. Measure so as to ensure that a 3/8" (10mm) space will be left between the laminate floor and the vertical part of the molding.
2. Install the laminate floors up to the measured point.
3. Install the molding.

E. T-Molding

T-moldings are used in areas where the room is larger than 40' (12m) in board length or wider than 40' (12m) in board width. T-moldings should also be used where the flooring continues through a doorway or passageway into another room.

If installing with metal track:

1. Install track first
2. Install laminate floor up to track leaving a 3/8" (10mm) expansion space between the laminate floor and the vertical section of the molding.

If installing without metal track:

1. Measure so as to ensure that a 3/8" (10mm) space will be left between the laminate floor and the vertical part of the molding (both sides of the T-molding if applicable).
2. Install the laminate floors up to the measured point.
3. Install the molding.

F. Stair Nosing

Stair Nosing is used on landings or stairs.

IMPORTANT: Stair Nosing should always be installed with nails and adhesive so as to ensure a safe and secure fit:

1. If your stair treads have existing bull-nosing remove the bull nosing so as to have a 90-degree angle between tread and riser.
2. Begin at the bottom riser, measure and cut a piece of laminate flooring to fit flush with the sub-floor.
3. Glue the piece of flooring to the riser by applying a 3" serpentine bead of construction adhesive to the back of the flooring.
4. Press the flooring in place.
5. Measure and cut the stair nose molding to length.
6. Measure and cut piece of laminate flooring to width of your stair-tread (depending on the depth of your stairs you may need to use more than one piece of flooring).
7. Install the laminate flooring by gluing it to the stair-tread in the same manner as you did the riser, ensuring that a 3/8" (10mm) expansion space is left between the edge of the floor and the vertical part of the stair nosing.

Note: If installing on a landing, install flooring as per the normal procedures, not by gluing it to the sub-floor.

8. Pre-drill holes on stair nose molding for 6d finishing nails.
 9. Adhere stair nose molding to stair-tread with construction adhesive (apply 3/16" bead of adhesive in a 3" repeating serpentine pattern to the back of the stair nose).
 10. Anchor stair nose molding with 6d finishing nails.
 11. Always ensure you use mechanic (nail) and adhesive (glue) fasteners to secure the stair nose molding.
-

10. CARE & MAINTENANCE

inhaus® laminate floors are among the highest performing floors available, but they are not indestructible and minor cosmetic scuffing is normal wear for any laminate floors. To ensure your floors perform as well in the future as they do the day after you install them:

- Place walk off mats and area rugs at main traffic entrances and protective pads under furniture legs to prevent scratching.
- Vacuum or dust mop to remove loose dirt or grit.
- Never flood the floor with water or cleaner; wipe up spills immediately.
- Do not use polishes, waxes or abrasive cleaners.

A. Removing Stains from Laminate Flooring

Stain:	Remove with:
Rubber marks Heel marks, dirt Colored pens/crayons	Brush off when dry using a nylon pad or cloth.
Beverages (fruit juices, milk, wine, soft drinks, etc.)	Immediately wipe down with an absorbent cloth. If already dry, wipe with a suitable laminate flooring cleaner.
Urine Blood	Immediately wipe down with an absorbent cloth. If already dry, wipe down with a nylon pad and a suitable flooring cleaner.
Felt pens/ink Makeup Shoe polish, paints, oils, grease, etc.	Wipe down with a cloth and a small amount of solvent, i.e. acetone, vinegar, nail polish remover, or paint thinner, etc.
Chocolate (and other food stains)	Use a suitable laminate flooring cleaner.